

E Fitting Instructions:
D Montageanleitung:
NL Montage instructie:

VPS SIDE BAR + LED
VPS SEITENSCHWELLER + LED
VPS SIDE BARS + LED

VW T6.1 2020➔



6559013
6559018
6559058

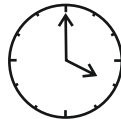

125 Min.





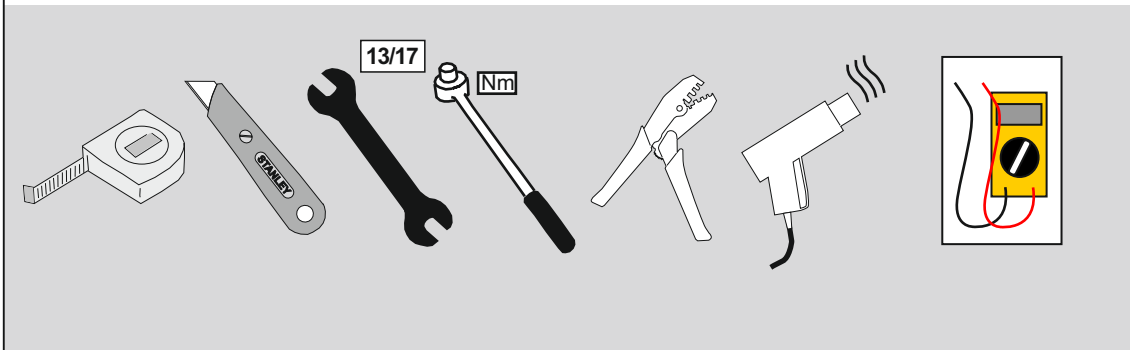





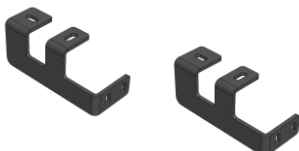
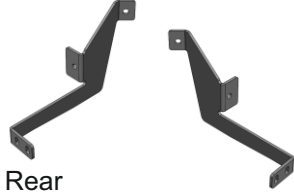
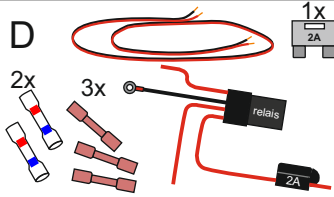

All rights reserved to modify the text

Required tools / Benötigte Werkzeuge / Benodigde werktuigen / Outillage requis
 Herramientas necesarias / Utensili necessari / Verktug somsomkrävs



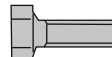
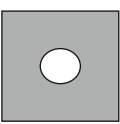





Parts list / Teileliste / Onderdelenlijst / Liste de pièces
 Lista de accesorios / Lista di pezzi / Artikel lista

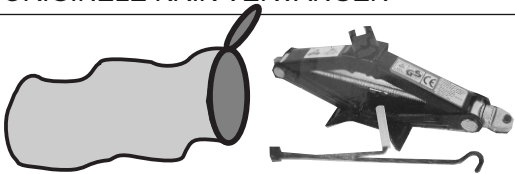

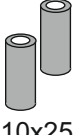
		2x	
			
		2x	1x
		 M8 15x30	 M8 15x40
2x	8x	2x	4x
 M8x20	 M8x20	 M8x25	 M8
4x	8x	4x	2x
 M8	 M8	 M10x30	 Ø12 40x40
2x	4x	4x	
 M10x30x4	 M10	 M10	

REPLACE ORIGINAL JACK
 ORIGINAL WAGENHEBER AUSTAUSCHEN
 ORIGINELE KRIK VERVANGEN



 10x25	 Ø4	 M4	 M4	 M4
 Ø 53	 600mm			

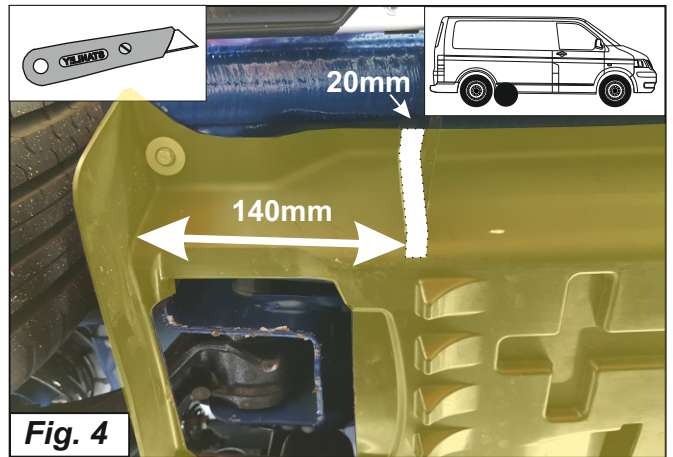
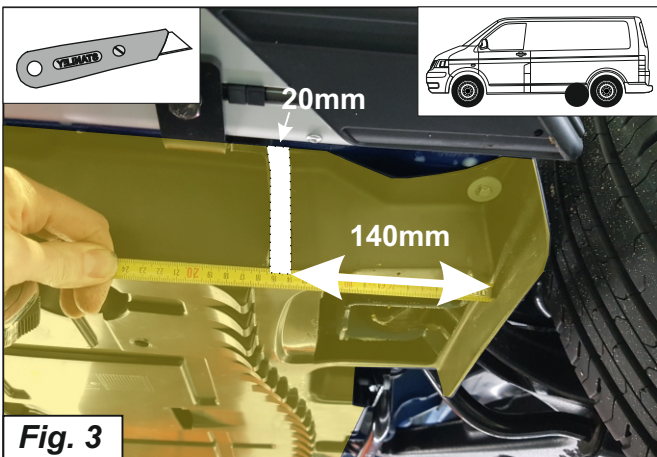
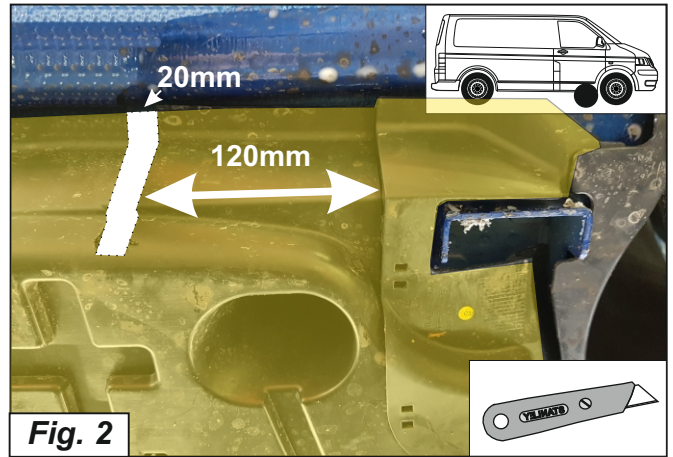
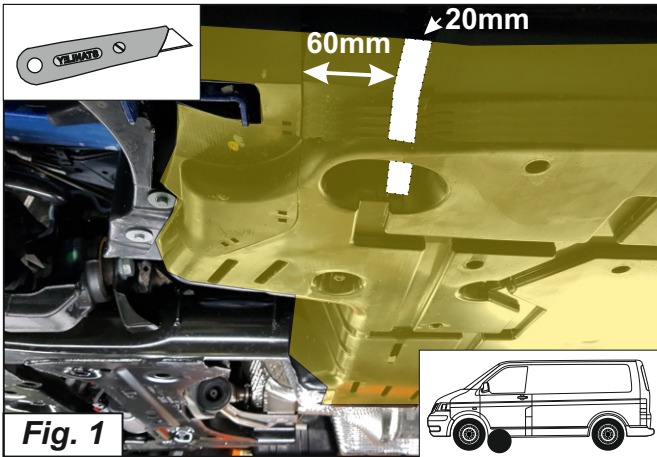

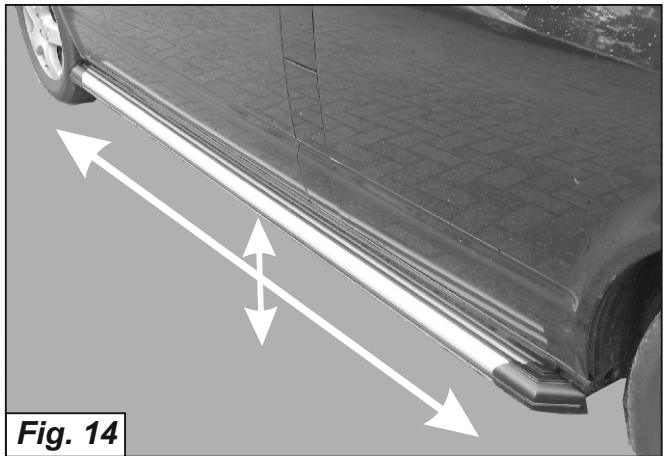
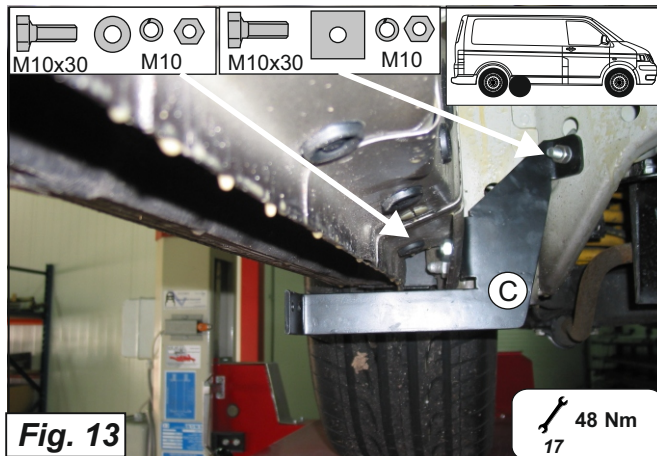
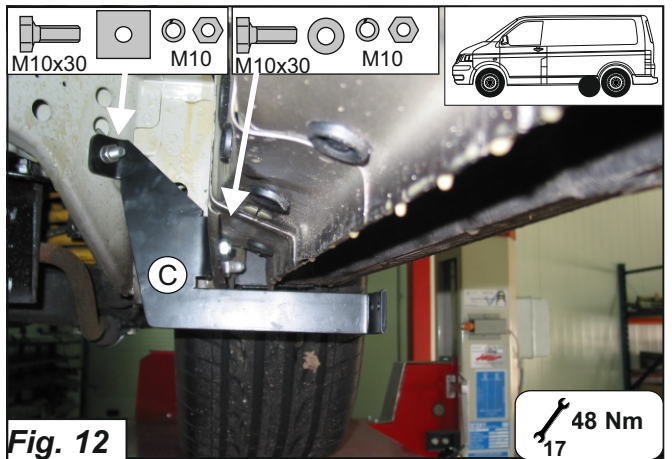
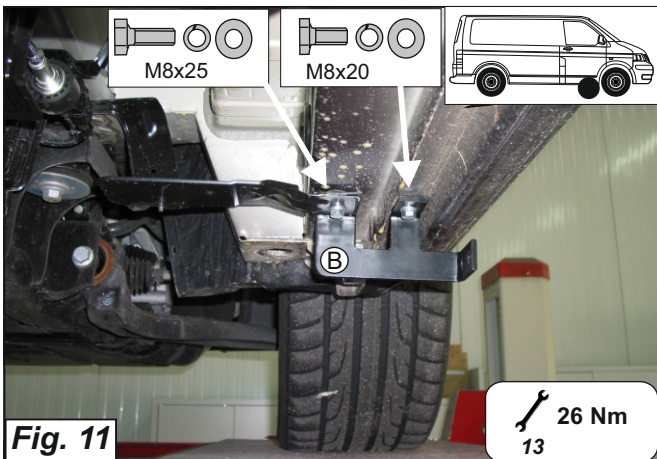
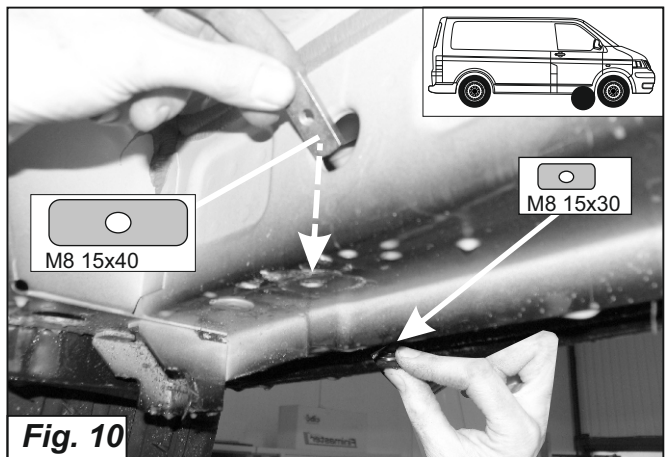
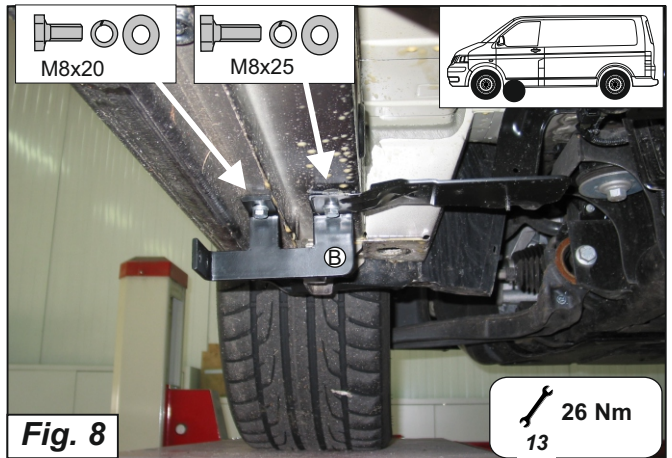
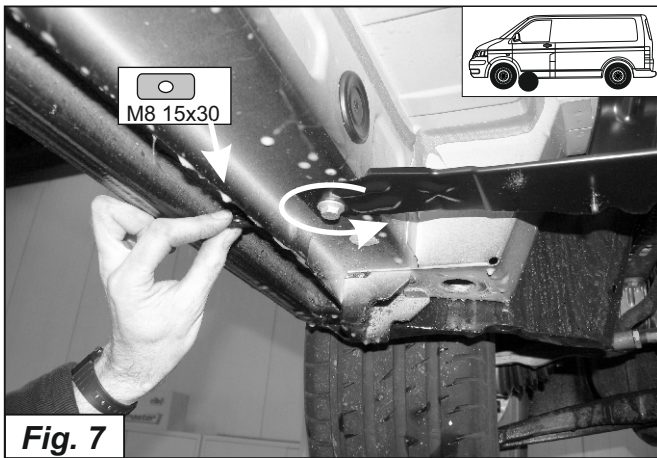

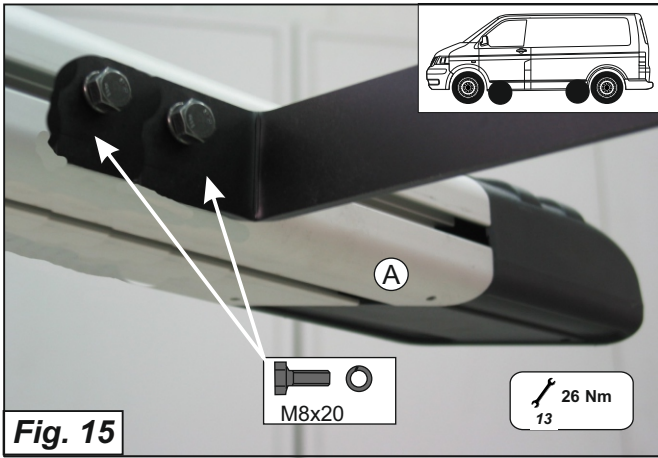

Transporter without upholstery

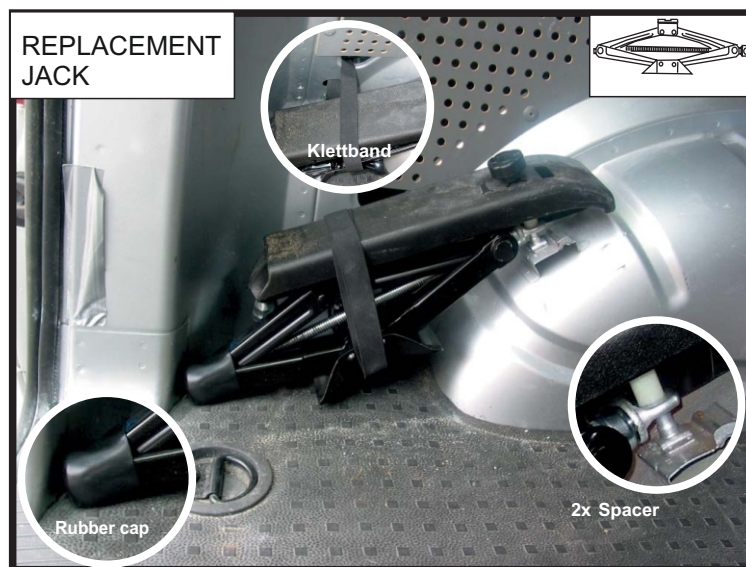
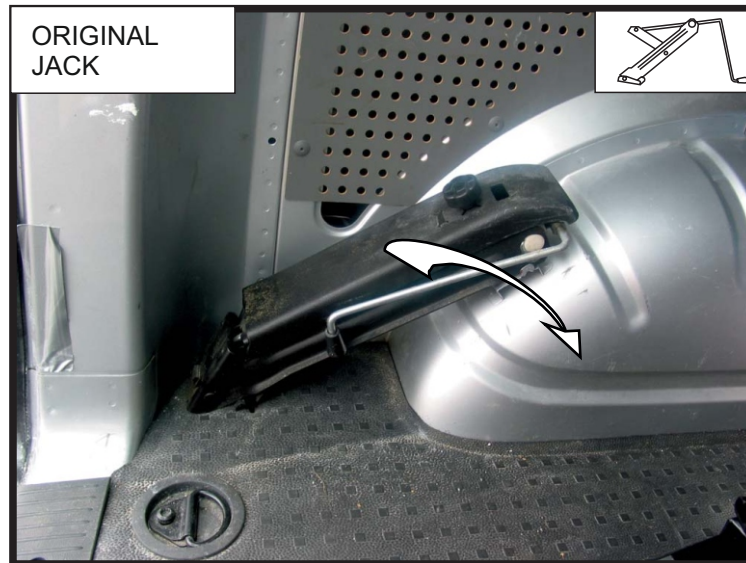

Transporter with upholstery

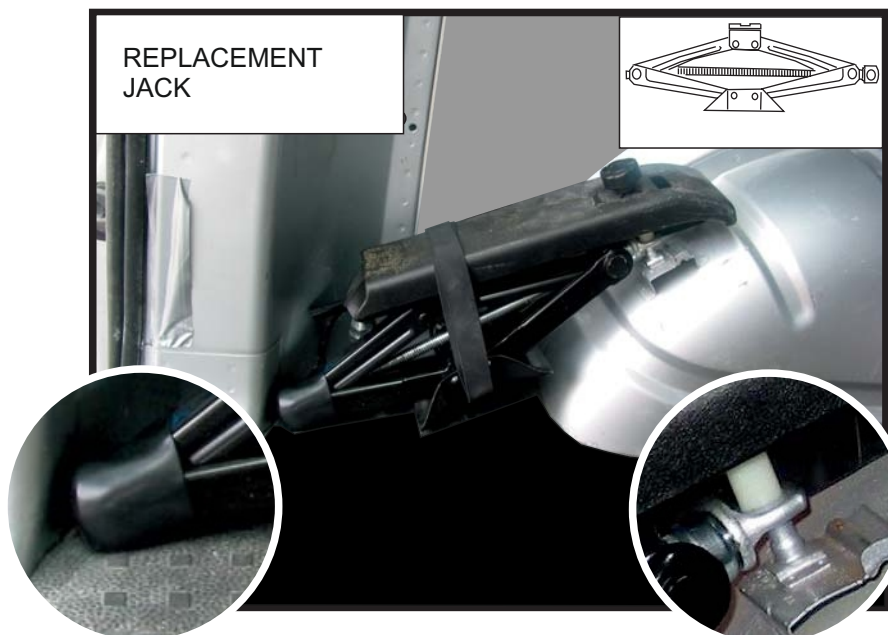
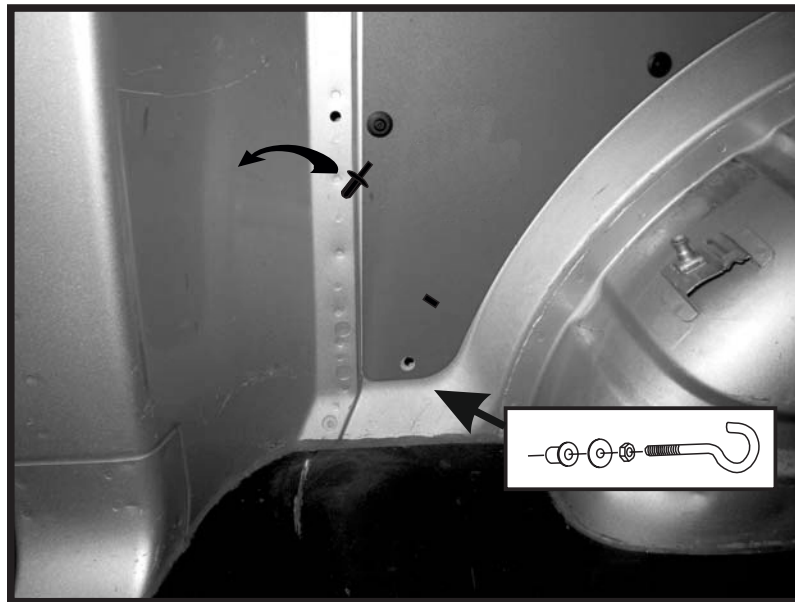
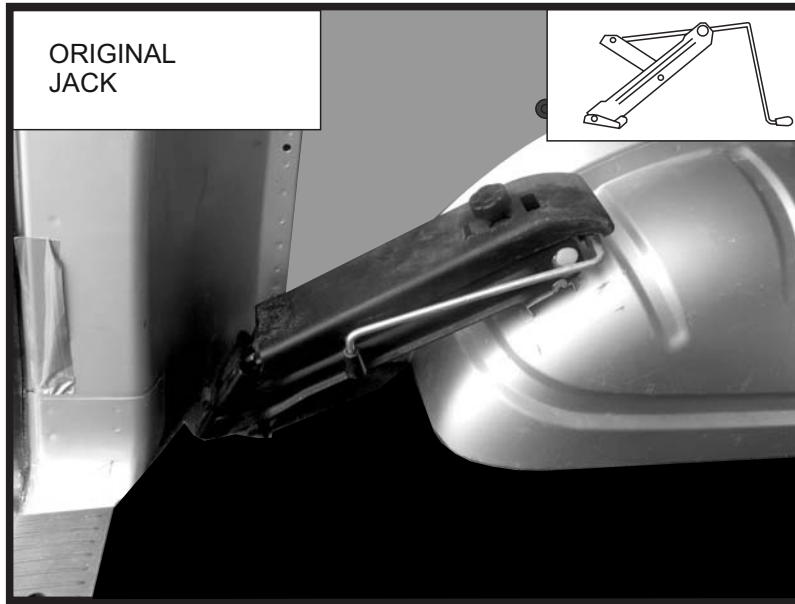

Rubber cap

2x Spacer

Multivan / Caravelle

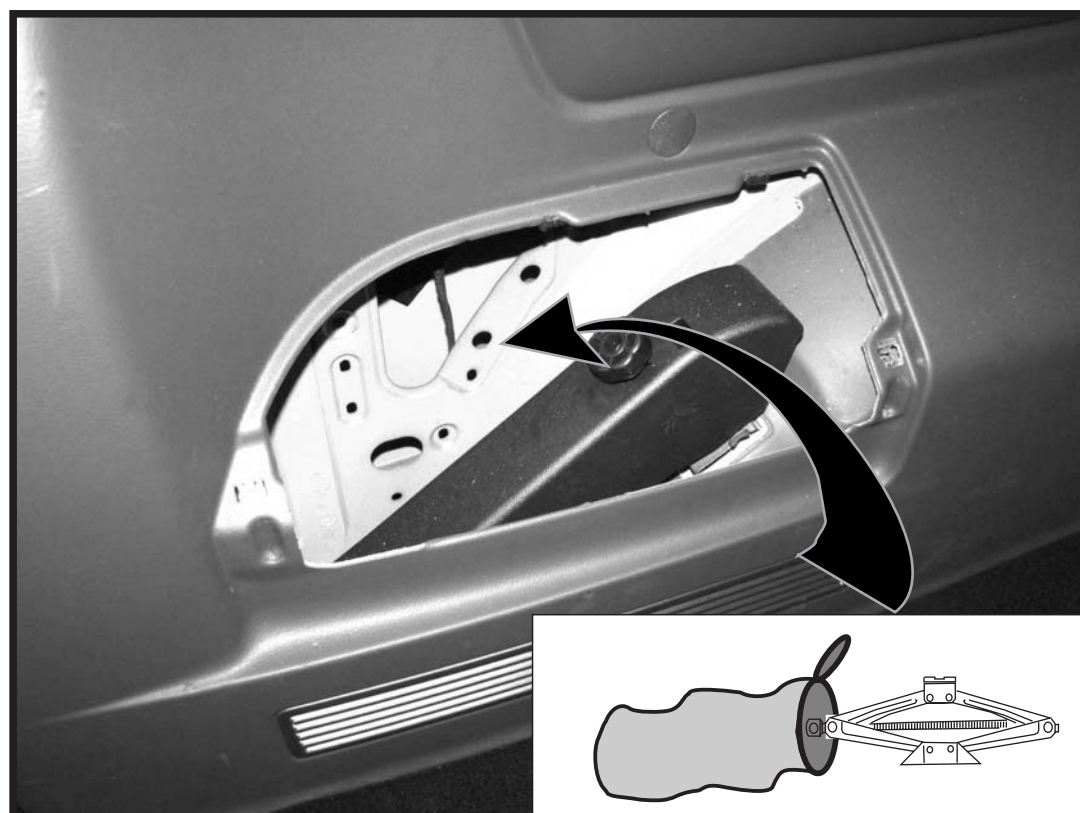
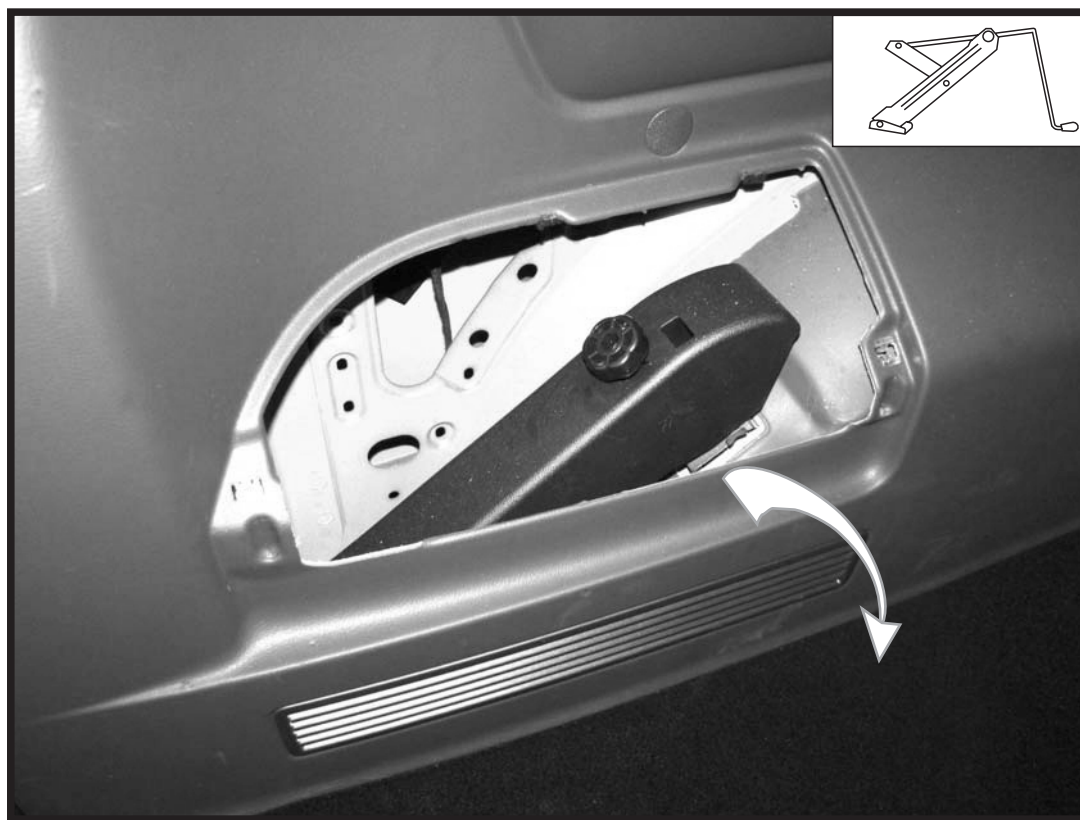

Bij auto's zonder instapverlichting, de verlichting van de sidebars bij regelapparaat elektrische installatie -J519- aansluiten.

Zwarte Stekker T73a/68 bruin/witte draad (voor juiste positie zie ELSA) (SIG)

Zwarte Stekker T73b/69 rood/zwarte draad (voor juiste positie zie ELSA) (KL30)

Bij auto's met instapverlichting, de verlichting van de sidebars bij koppel plek in linker stoelframe aansluiten.

Grijze stekker T10bo/8 bruin/witte draad (voor juiste positie zie ELSA) (SIG)

Grijze stekker T10bo/7 rood/zwarte draad (voor juiste positie zie ELSA) (KL30)

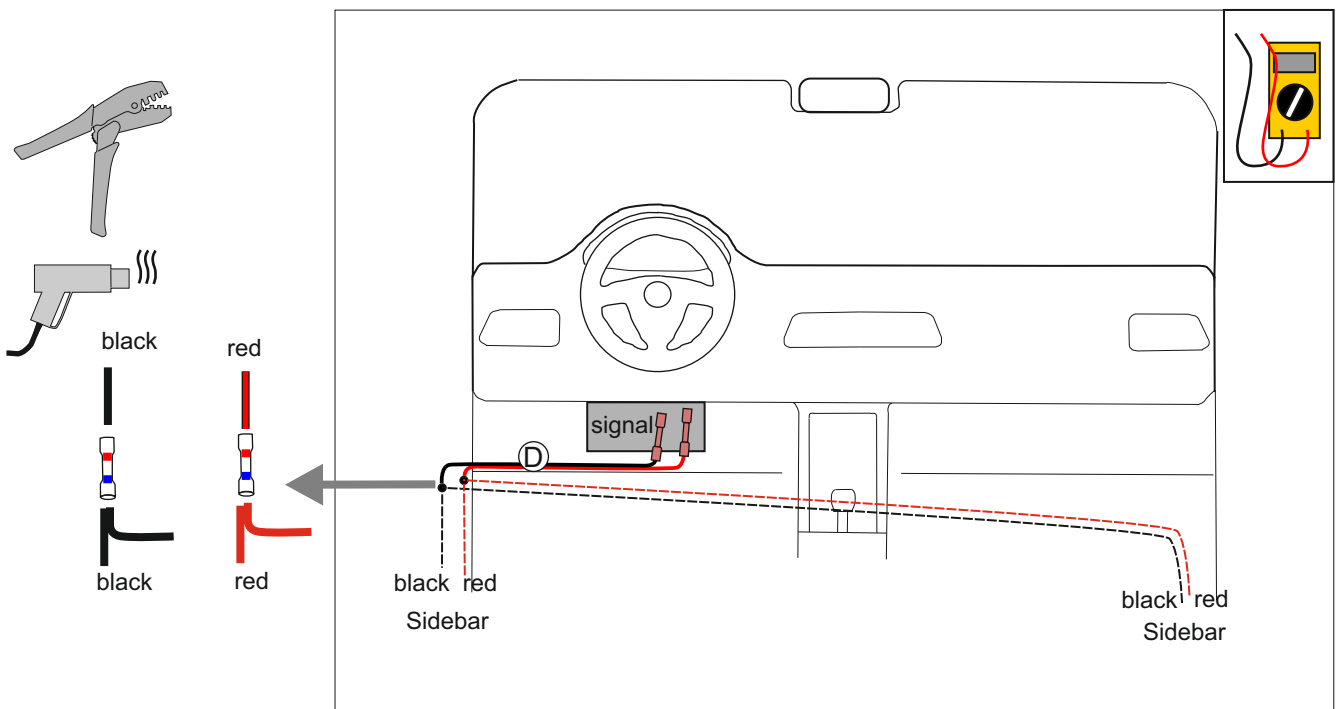

Om te voorkomen dat de verlichting brandt (of ingeschakeld kan worden) tijdens het rijden, kan het mee geleverd (verbreek)relais aangesloten worden.

